

A520007 WINDTEC A520008 WINDTEC LUX

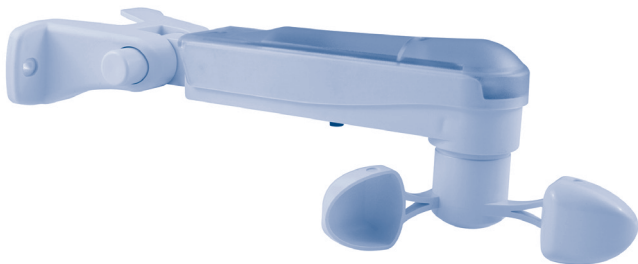

SENSORE VENTO E VENTO/LUCE

IT

WIND SENSOR & SUN SENSOR

EN

WETTERSTATION WINDWÄCHTER & SONNENSENSOR

DE

CAPTEUR DE VENT ET DE VENT-LUMIÈRE

FR

ANEMÓMETRO CON SENSOR LUZ
PARA EL CONTROL DEL TOLDO

ES



Table of contents:

Safety instructions	p. 20
Warnings for installer / user	p. 21-22
Technical features	p. 22
Compatibility	p. 23
Electrical connections.....	p. 23
LUX Function.....	p. 24
Compatible remote controls	p. 25
Key to symbols	p. 25-26
Command sequences example	p. 26
Where to place the Wind & Sun sensor	p. 27
Setting of several motors to one sensor	p. 27
Fitting the Wind & Sun sensor	p. 28
Setting the Wind & Sun sensor	p. 29
Deleting the Wind & Sun sensor	p. 29
Setting the Wind sensor	p. 30
Activating automatic reopening.....	p. 30
Deactivating automatic reopening.....	p. 31
Setting the Sun sensor (WindTec Lux)	p. 31
Activating the automatic or manual setting mode by the remote control series Giro.....	p. 32
Activating the automatic or manual setting mode by the remote control series POP.....	p. 33
Activating the automatic or manual setting mode by the remote control series Skipper.....	p. 33
Test mode.....	p. 34
EU Declaration of conformity.....	p. 34

These safety instructions supplement the product instructions. Please give these instruction to the final user after installation.

 **WARNING: IMPORTANT SAFETY INSTRUCTIONS**

It is important for the safety of persons to follow these instructions.

WARNING: the appliance shall be disconnected from its power source during cleaning, maintenance and when replacing parts.

 - This product has been designed for the automation of external awnings on the basis of the wind speed and light intensity (WINDTEC LUX model). Any other use is improper. Special applications shall be submitted to Cherubini S.p.A.'s analysis and approval.

- Only professional technicians must perform installation, complying with all safety instructions, especially those regarding electrical connections.
- This product is not intended for use by children under 8 years of age or by persons with reduced physical, sensory or mental capabilities, or lack of experience or knowledge. Cleaning and maintenance intended to be carried out by the user must not be carried out by unsupervised children.
- Do not allow children to play with awning driving. Keep remote controls out of the reach of children.
- Awnings: do not operate the awning when maintenance, such as window cleaning, is being carried out in the vicinity.
- Disconnect the automatically controlled awning from the supply when maintenance, such as window cleaning, is being carried out in the vicinity.
- Frequently examine the installation in order to detect any out-of-balance condition and signs of wear or damage to cables and springs. Do not use if repair or adjustment is necessary.
- The supply cord of this appliance can be replaced only by the same type of cable supplied by Cherubini S.p.A.
- The acoustic emission level of this appliance is lower than 70dBA: LpA < 70dB(A).
- These instructions are also available at the following internet address:
<https://www.cherubini.it/academy/elenco-prodotti/sensore-windtec-e-windtec-lux-15>.

WARNINGS FOR INSTALLER

 **WARNING: Important safety instructions. Follow all instructions, since incorrect installation can lead to severe injury.**

- Before installation, check the compatibility of this product with tubular motors and associated accessory devices.
- The device must be installed more than 2.5 m from the floor or other plane that could allow access.
- Adjusting devices have to be clearly visible after installation.
- The device must be protected against overloads by a circuit-breaker with a rated current not exceeding 10 A and a high-current fast-blow fuse type TO,315AH/250V.
- Before installation, remove any unnecessary cables and switch off any equipment not required for powered operation.
- Before any maintenance, installation or cleaning work, switch off the power supply.
- If the supply cord is damaged, it must be replaced by Cherubini Service in order to prevent any risk.
- If in doubt when installing the device or for more information, consult a CHERUBIN S.p.A. technician or visit the website at:
<https://www.cherubini.it/academy/elenco-prodotti/sensore-windtec-e-windtec-lux-15>

WARNINGS FOR USER

- Do not service or repair the product: refer to competent technical personnel.
-  If the supply cord is damaged please call the assistance centre or qualified technical staff, in order to avoid any hazard.
- Do not subject the product to crushing, knocks, falls or contact with liquids of any kind; do not drill holes or apply screws.
- The guarantee does not cover any damage caused by misuse, straining, tampering or incorrect connections.

WARNINGS FOR USER

 **WARNING:** CHERUBINI S.p.A. accepts no liability for material damage caused by climatic events that cannot be detected by the wind sensor.



This sensor does not protect motorised products in the event of strong gusts of wind. The maximum wind speed detectable by the sensor is 45 km/h.

In the event of strong gusts of wind, please ensure that the awning is fully retracted.

TECHNICAL FEATURES

There are two versions of the WindTec sensor:

- WindTec: Wind sensor
- WindTec Lux: Wind & Sun sensor.

	WINDTEC WIND SENSOR 	WINDTEC LUX WIND & SUN SENSOR 
Power supply (V) / (Hz)	230 / 50	230 / 50
Radio frequency (MHz)	433,92	433,92
Setting Wind sensor (km/h)	7,5 - 45	7,5 - 45
Maximum RF power transmitted	4 mW (5,6 dBm)	4 mW (5,6 dBm)
Rated impulse voltage (kV)	2,5	2,5
Setting Sun sensor (klux)		2,5 - 100
Degree of protection	IP34	IP34
Dimensions (mm)	300x140xH95	300x140xH95
Weight (g)	365	365
Operating temperature	-10° +40° C	-10° +40° C
Storage temperature	-25° +40° C	-25° +40° C
Altitude max	2.000 m	2.000 m
Software	1.010	1.010

COMPATIBILITY

According to the motor / control unit to which the WindTec is associated, the availability of certain features changes as indicated in the following table:

	CLOSING BY WIND ALARM	AUTOMATIC REOPENING	OPENING AND CLOSING WITH LIGHT*	ADDITIONAL MIDDLE POSITION*	"PRIVACY" POSITION*
WAVE RX / SENSO RX	√	√	√	√	
ORA ZRX / REBIS ZRX	√	√	√	√	
GARDA RX / OCEAN RX	√	√	√	√	
Radio receiver TDS COMPACT	√		√	√	
Radio receiver TDS GOLD	√		√		
Radio receiver MINI/MYROLL	√		√		
Radio receiver ORIENS CRC	√		√		√

*only with WindTec Lux

ENGLISH

ELECTRICAL CONNECTIONS

WINDTEC A520007

WINDTEC LUX A520008

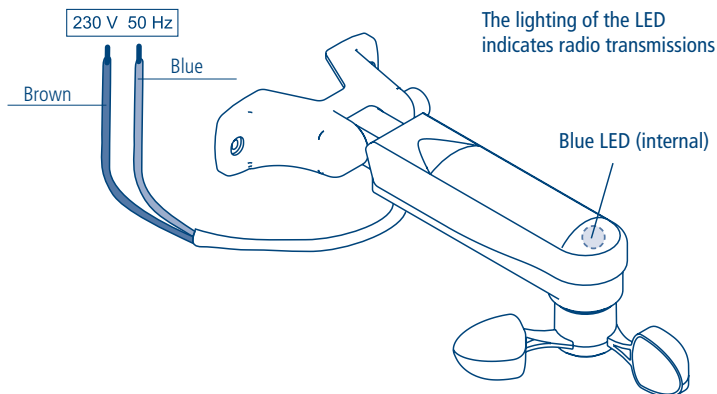

LUX FUNCTION

ATTENTION! The light function in model "WindTec Lux" can be activated only by using a remote control series SKIPPER, GIRO or POP with the LUX function (Skipper Lux / Skipper P-Lux, Giro Lux / Giro P-Lux or POP Lux / POP P-Lux).

Series SKIPPER

SKIPPER LUX

SKIPPER P-LUX

Activating/ Deactivating the Sun sensor



Wind & Sun sensor activate.



Only Wind sensor activate.

Series GIRO

GIRO Lux

Activating the Sun sensor

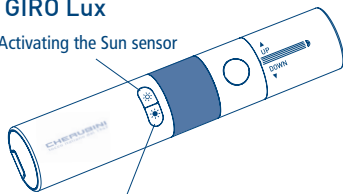

Deactivating the Sun sensor



Wind & Sun sensor activate.

GIRO P-Lux

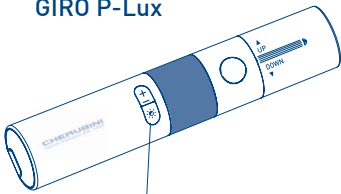

Activating/ Deactivating the Sun sensor



Only Wind sensor activate.

Series POP

POP Lux

POP P-Lux

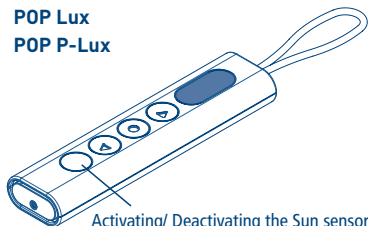

Activating/ Deactivating the Sun sensor



Wind & Sun sensor activate.



Only Wind sensor activate.

COMPATIBLE REMOTE CONTROLS

GIRO

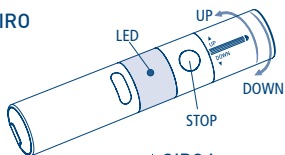

GIRO Wall

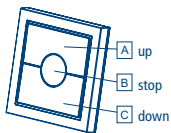

GIRO Plus

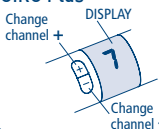

GIRO Lux

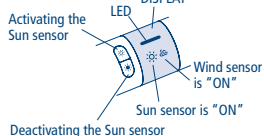

GIRO P-Lux

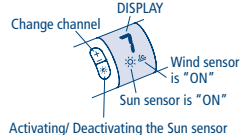

POP

POP Lux

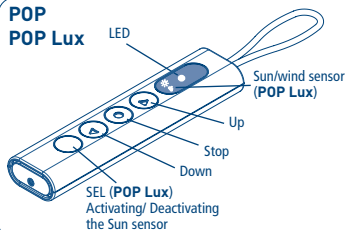

POP Plus

POP P-Lux

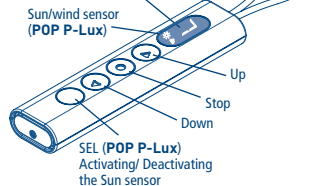

SKIPPER
SKIPPER **LUX**
SKIPPER **PLUS**
SKIPPER **P-LUX**

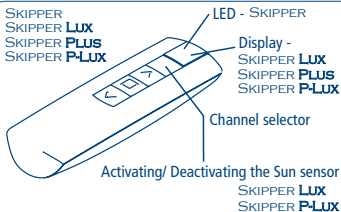

SKIPPER **LCD**
SKIPPER **SENSO**

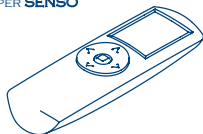

Check the specific instruction book

KEY TO SYMBOLS

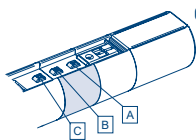

GIRO

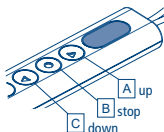

POP

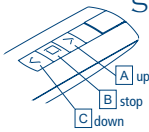

SKIPPER



KEY TO SYMBOLS

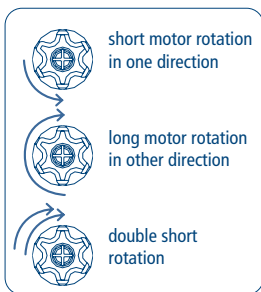
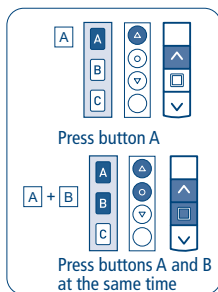
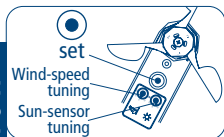
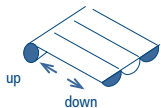

COMMAND SEQUENCES EXAMPLE

Most of the command sequences have three distinct steps, at the end of which the motor indicates if the step has been concluded positively or not, by turning in different ways. This section is provided to demonstrate the motor indications. The buttons must be pressed as shown in the sequence, without taking more than 4 seconds between one step and the next. If more than 4 seconds are taken, the command is not accepted and the sequence must be repeated. Command sequence example:

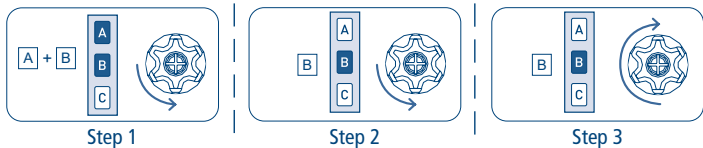

As we can see from the example, when the sequence ends positively, the motor returns to its starting position in one long rotation. In fact, two short rotations in the same direction correspond to one long rotation in the opposite direction. The motor returns to the starting position even when the sequence is not completed; in this case by performing one or two short rotations. Example of a wrong sequence:

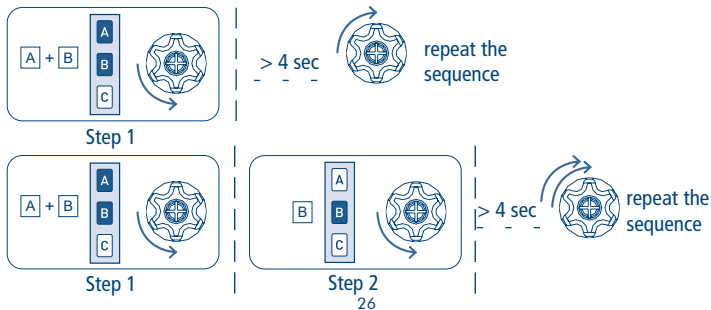

ATTENTION! WHERE TO PLACE THE WIND & SUN SENSOR

The WindTec sensor must be positioned to the side, as close as possible to its awning, and not above or below the awning coverage area.

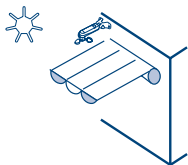

RIGHT

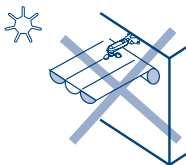

WRONG

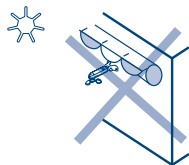

WRONG

SETTING OF SEVERAL MOTORS TO ONE SENSOR

One single WindTec sensor can be used to automate a group of motorised awnings. For a correct function, the coupled awnings must be mounted and exposed to sunlight and wind in the same way. Do not connect more than 5 motors to one wind sensor.

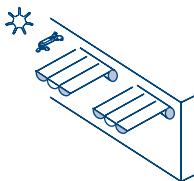

RIGHT

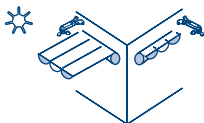

RIGHT

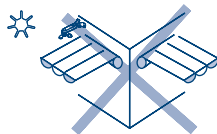

WRONG

CAUTION: In order to avoid 'overcrowding' of radio transmissions, resulting in malfunctioning of the sensors and other radio equipment themselves, it is necessary to minimise the density of installed sensors by associating several motors/control unit with the same sensor, bearing in mind that each sensor can work effectively within a range of 10 to 15 metres, and that a maximum of 5 sensors may be installed within the same 10 to 15 metre range.

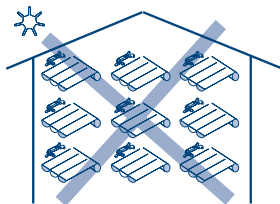

NO

FITTING THE WIND & SUN SENSOR

The WindTec sensor has a positioning mechanism for fitting to any surface.
To adjust fitting-angle, press the button to rotate the support (see drawing).

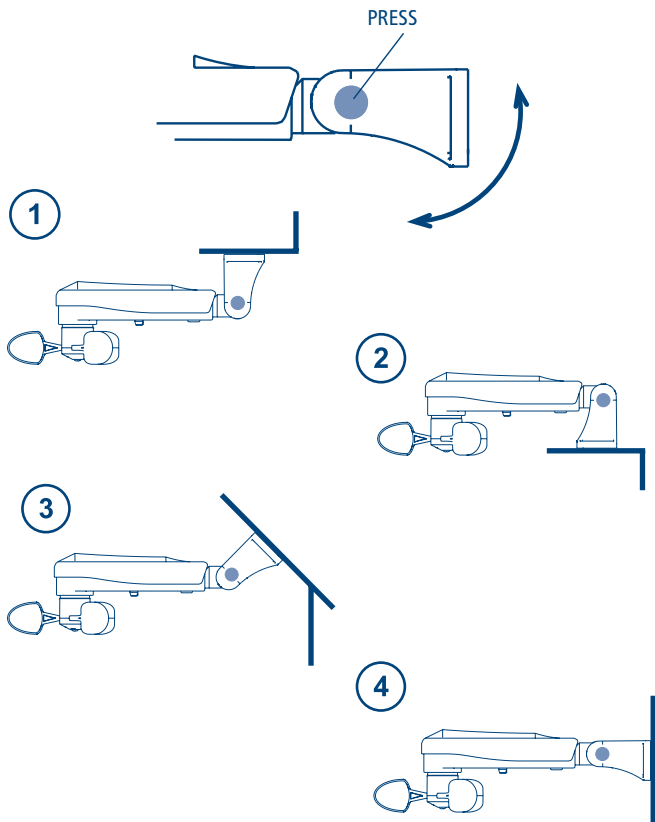

SETTING THE WIND & SUN SENSOR

To associate WindTec sensor to a motor, a remote control must be already memorised on the motor. The setting sequence is the following:

Tn: Already programmed remote control

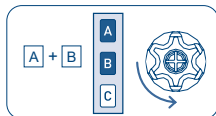

Tn

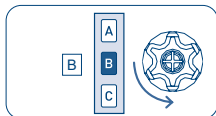

Tn



2 sec

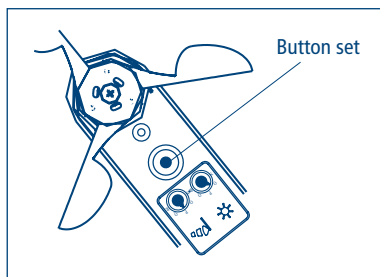

DELETING THE WIND & SUN SENSOR

To delete the WindTec sensor from the motor, an already programmed remote control must be used. The deleting sequence is the following:

Tn: Already programmed remote control

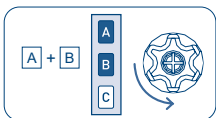

Tn

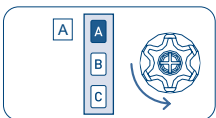

Tn



2 sec

SETTING THE WIND SENSOR

The wind level point can be set using the button provided in the lower part of the WindTec sensor, identified by the windsock symbol. The speed can be set from a minimum of 7,5 Km/h to a maximum of 45 Km/h.



It's prudent not to set the wind speed over the fourth level, which corresponds to 35 Km/h.

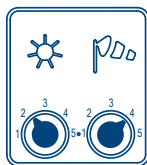
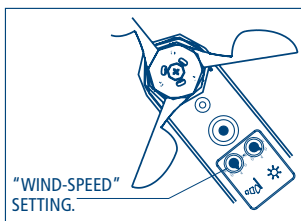

MAXIMUM RECOMMENDED SPEED
FOR THE WIND-ALARM (35 km/h)

Following a wind alarm, the motor closes automatically the awning, overriding user commands until the wind alarm passes. To deactivate the wind alarm, it's necessary that the wind speed remains below the set level for at least 8 minutes. After these 8 minutes the awning returns to the position it was in before the alarm, if the automatic reopening function is active. This pause time is included to ensure awning protection and to prevent continuous motor movement in the event of sporadic gusts of wind.

ACTIVATING AUTOMATIC REOPENING

- only with WAVE RX / SENSO RX / ORA ZRX / REBIS ZRX motors -

With the automatic reopening system, at the end of the wind alarm, the awning opens again. From factory this function is not activated in the motor, but can be easily activated with the following command sequence:

Tn: Already programmed remote control

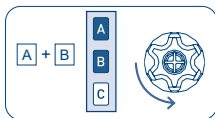

Tn

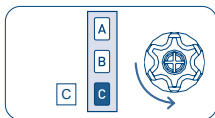

Tn

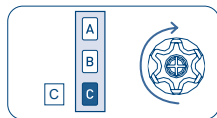

Tn (2 sec)

DEACTIVATING AUTOMATIC REOPENING

- only with WAVE RX / SENSO RX / ORA ZRX / REBIS ZRX motors -

The automatic reopening function can be deactivated at any moment with the following command sequence:

Tn: Already programmed remote control

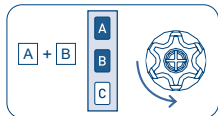

Tn

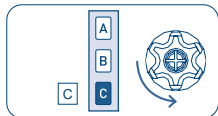

Tn

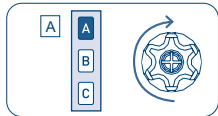

Tn (2 sec)

SETTING THE SUN SENSOR

(WindTec Lux)

The light level point can be set using the button provided in the lower part of the WindTec Lux sensor, identified by the sun symbol.



The light intensity can be set from a minimum of 2.5 kLux (dawn light) up to a maximum of 100 kLux (midday sunlight). To activate the automatic awning opening, the light intensity must exceed the set level for 1 minute, while for automatic closing, the light intensity must remain below the set level for at least 10 minutes. These pause times are included to prevent the motor from moving continuously in the event of passing clouds. Automatic opening and closing only work when the motor is set to the automatic wind + light mode.

ACTIVATING THE AUTOMATIC OR MANUAL SETTING MODE BY THE REMOTE CONTROL SERIES GIRO

The manual mode (wind only), or automatic mode (wind + sun) setting has to be done by the Giro Lux or Giro P-Lux remote control.



Wind & Sun sensor activate.



Only Wind sensor activate.

Using the front buttons on the remote control do the following:

GIRO Lux

By pressing briefly one button the display will show the current setting.



Activating



Deactivating

To change setting, press for at least 3 seconds the button related to the desired function, till the motor feedback.



(3 sec)



GIRO P-Lux

By pressing briefly the button the display will show the current setting.



Activating/ Deactivating

To change setting press the same button for at least 3 seconds till the motor feedback.



(3 sec)



ACTIVATING THE AUTOMATIC OR MANUAL SETTING MODE BY THE REMOTE CONTROL SERIES POP

The manual mode (wind only), or automatic mode (wind + sun) setting has to be done by the POP Lux or POP P-Lux remote control.



Wind & Sun sensor activate.



Only Wind sensor activate.

By briefly pressing the "SEL" button, the remote control shows the current setting. To change the setting press the SEL button again and hold it down for around 2 sec, until the motor replies with a confirmation sequence.

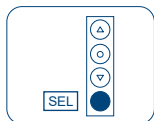

Tn

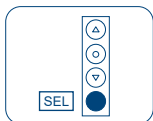

Tn (2 sec)



ACTIVATING THE AUTOMATIC OR MANUAL SETTING MODE BY THE REMOTE CONTROL SERIES SKIPPER

The manual mode (wind only), or automatic mode (wind + sun) setting has to be done by the Skipper Lux or Skipper P-Lux remote control.



Wind & Sun sensor activate.



Only Wind sensor activate.

By briefly pressing the "SEL" button, the remote control shows the current setting. To change the setting press the SEL button again and hold it down for around 2 sec, until the motor replies with a confirmation sequence.

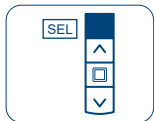

Tn

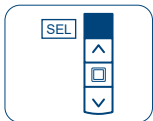

Tn (2 sec)



TEST MODE

This function is useful to check the correct communication via radio, and to perform the wind and sun function test.

To activate the TEST function, hold the SET button down for around 2 seconds, until the motor confirms the command by bringing the awning to half opening distance. The test function lasts for 3 minutes, during which the wind and light level settings can be checked, without waiting for the activation times. After 3 minutes, the WindTec sensor returns to normal mode function.



(2 sec)

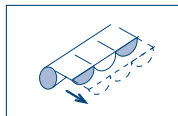

WIND FUNCTION TEST

To avoid errors during the wind function test, we advise setting the motor to manual mode (wind only). With the anemometer blades moving, when the speed detected by the sensor exceeds the set level, the motor will close completely the awning. After the awning is closed and the anemometer blades stop turning, the awning returns to halfway out if the automatic reopening function is active; if it is not, the awning remains closed.

SUN FUNCTION TEST (WindTec Lux)

Check that the motor is set to the automatic mode. When the sensor detects a change in light intensity, it opens the awning if brighter than the set point or closes it if weaker. This test can be repeated several times to establish the desired automatic opening and closing level according to the light.

EU DECLARATION OF CONFORMITY



The Manufacturer CHERUBINI S.p.A. declares that the radio equipment type WindTec and WindTec Lux are in conformity with the Directive 2014/53/EU.

The full text of the EU declaration of conformity is available at:

<https://www.cherubini.it/academy/elenco-prodotti/sensore-windtec-e-windtec-lux-15>.

CHERUBINI S.p.A.

Via Adige 55
25081 Bedizzole (BS) - Italy
Tel. +39 030 6872.039 | Fax +39 030 6872.040
info@cherubini.it | www.cherubini.it

CHERUBINI Iberia S.L.

Avda. Unión Europea 11-H
Apdo. 283 - P. I. El Castillo
03630 Sax Alicante - Spain
Tel. +34 (0) 966 967 504 | Fax +34 (0) 966 967 505
info@cherubini.es | www.cherubini.es

CHERUBINI France SAS

ZI Du Mas Barbet
165 Impasse Ampère
30600 Vauvert - France
Tél. +33 (0) 466 77 88 58
info@cherubini.fr | www.cherubini.fr

CHERUBINI Deutschland GmbH

Siemensstrasse, 40 - 53121 Bonn - Deutschland
Tel. +49 (0) 228 962 976 34 / 35 | Fax +49 (0) 228 962 976 36
info@cherubini-group.de | www.cherubini-group.de

