

CHERUBINI

tocco italiano dal 1947



A510088 META DRY CONTACT SWITCH ZRX



Relè a singolo canale **IT**

Single channel relay **EN**

Einkanal-Relais **DE**

Relais monocanal **FR**

Relé un canal **ES**



ISTRUZIONI - INSTRUCTIONS - EINSTELLANLEITUNGEN
INSTRUCTIONS - INSTRUCCIONES

Index:

Device description	p. 30
Technical specifications.....	p. 31
Safety information	p. 31
Electrical connections diagram	p. 32
Device installation.....	p. 33
LED status indicator	p. 33
Add/remove the device into a Z-Wave™ network (classic).....	p. 34
SmartStart inclusion.....	p. 35
S2 Secure Inclusion	p. 35
Supported command classes	p. 36-37
Device control	p. 38
Controlling the device by External Switches	p. 38
Controlling the device by a Z-Wave™ controller	p. 39
Associations.....	p. 40
Timer management.....	p. 41
Reset to the factory settings	p. 41
Firmware update.....	p. 41
Offline setup mode	p. 42
Configurations	p. 43
Association of a Cherubini remote control SKIPPER - POP or GIRO series	p. 51

EU declaration of conformity

CHERUBINI S.p.A. declares that the product is in conformity with the relevant Union harmonisation legislation: Directive 2014/53/EU, Directive 2011/65/EU.

The full text of the EU declaration of conformity is available upon request at the following website: www.cherubini.it.

Failure to comply with these instructions annuls CHERUBINI's responsibilities and guarantee.



The crossed-out wheellie bin symbol indicates that the product must be collected separately from other waste at the end of its useful life. Therefore, users should deliver this product to appropriate waste collection points or return it to their dealers at the end of its service life. See your local authority's regulations.

Adequate waste sorting for subsequent processing and environmentally compatible disposal helps to avoid possible negative effects on the environment and public health and promotes reuse and/or recycling of the materials used to make the equipment.

DEVICE DESCRIPTION

Meta Dry Contact Switch ZRX can turn ON and OFF equipment's with an independent power supply, such as solenoid valves (e.g. gas, water and irrigation), power operated valves etc.

It is very easy to install and works with both momentary and toggle switches.

It operates in any Z-Wave™ network with other Z-Wave™/Z-Wave Plus™ certified devices and controllers from any other manufacturer. As a constantly powered node, the device will act as repeater regardless of the vendor in order to increase the reliability of the network.

This device is a security enabled Z-Wave Plus™ product that is able to use encrypted Z-Wave Plus™ messages to communicate to other security enabled Z-Wave Plus™ products.

This device must be used in conjunction with a Security Enabled Z-Wave™ Controller in order to fully utilize all implemented functions.

The device can also be controlled by Cherubini remote controls of SKIPPER - POP or GIRO series.

Integrated Button
with LED indicator

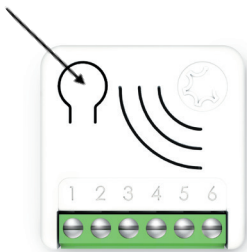

Integrated Button

1 or 3 clicks to enter in Learn Mode
6 clicks to reset the system to manufacturer's settings
2 clicks to enter in setup mode

Power Supply

1, 2 – Null
6 – Line

Input Switch

3 – Input - Line signal

Output

4, 5 – Dry Contact

TECHNICAL SPECIFICATIONS

Power supply	110 - 230 VAC \pm 10% 50/60 Hz - 24 VDC
Maximum Load on Relay	16A resistive Load
System temperature limitation	105 °C
Work temperature	From -10° to 40° C
Power consumption	< 260 mW in standby < 480 mW with working load
Radio frequency	868,4 MHz
Protection system	S2 Security
Maximum distance	Up to 100 m outdoor Up to 40 m indoor
Dimensions	37x37x17 mm
Actuator element	16 Amp relay
Compliance	CE, RoHs
Electrical IP Rating	IP20

SAFETY INFORMATION

 **INFO:** The device is designed to be installed in flush mounting junction boxes or close to the load to be controlled.

 **WARNING:** The device must be installed by electricians qualified to intervene on electrical systems in compliance with safety requirements set out by the regulations in force.

 **DANGER:** The device must be connected with a voltage of 230 VAC, before carrying out any operation, please make sure the power main switch is in OFF position.

 **DANGER:** Any procedure requiring the use of the Integrated Button is related only to the installation phase and is to be considered a service procedure that must be performed by qualified personnel. This operation must be performed with all necessary precautions for operating in areas with a single level of insulation.

 **WARNING:** Do not connect loads that exceed the maximum load permitted by the actuator element.

 **WARNING:** All connections must be performed according to the electrical diagrams provided.

 **WARNING:** The device must be installed in norm-compliant systems suitably protected from overloads and short circuits.

ELECTRICAL CONNECTIONS DIAGRAM

The device must be supplied by 230 AC or by 24 VDC Power Supply.

Connections must be done following one of the diagrams below: if you need to control a Load connected on a different power supply system you must follow the diagram on the right side.

ENGLISH

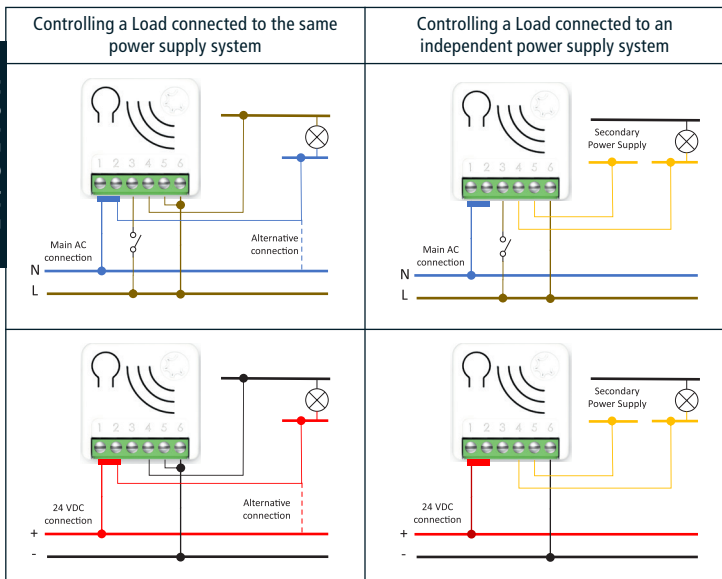

Power Supply

1, 2 – Null
6 – Line

Input Switch

3 – Input - Line signal

Output

4, 5 – Dry Contact



WARNING: The power line must be opportunely protected from short-circuits and excess load due to a failure of the load.

DEVICE INSTALLATION

- 1) Make sure the main switch is set to the OFF position
- 2) Connect the device based on the diagrams provided
- 3) Turn the main switch to the ON position
- 4) Include the device in the Z-Wave™ network



TIP: The antenna must not be shortened, removed or modified. To ensure maximum efficiency, it must be installed as shown. Large size metal equipment near the antenna can negatively affect reception. Each device is a node in a mesh network. If there are metal obstacles, the obstacle can often be overcome with a further triangulation node.



LED STATUS INDICATOR

The system includes an RGB LED that shows the device's status during installation:

Solid RED: the device is not included in any network

Solid BLUE: the device is Offline setup mode

4 GREEN blinks then OFF: the device has been just added to a Z-Wave™ network in S2 Authenticate Mode

4 BLUE blinks then OFF: the device has been just added to a Z-Wave™ network in S2 Unauthenticated Mode

4 RED blinks then OFF: the device has been just added to a Z-Wave™ network without security

Sequence of GREEN-BLUE Learn Mode for inclusion

Sequence of RED-BLUE Learn Mode for exclusion

Rapid sequence of GREEN-BLUE-RED: the event on the input (external switch) is not valid.



TIP: To test if the electrical connections are correct, before the inclusion of the device, while pressing **n** times the external switch, the RGB LED should flash **green** for the same amount of times. If it does not, check the wire connections.

ADD/REMOVE THE DEVICE INTO A Z-WAVE™ NETWORK (*classic*)

Standard Inclusion (add)

All META Serie 7 devices are compatible with all Z-Wave™/Z-Wave Plus™ certified controllers. The devices support both the **Network Wide Inclusion** mechanism (which offers the ability to be included in a network, even if the device is not directly connected to the controller) and **Normal Inclusion**.

By default, the inclusion procedure starts in **Normal Inclusion** mode and after a short timeout the procedure continues in **Network Wide Inclusion** mode that lasts for about 20 Seconds.

Only a controller can add the device into the network. After activating the inclusion function by the controller, the device can be added by setting it in Learn Mode.

Before including the device, the LED status indicator is solid RED. The adding of a device is executed by activating the adding procedure in the inclusion section of the controller interface and then executing 1 or 3 click on the integrated button. As soon as the inclusion procedure initiates the LED indicator starts a sequence of GREEN-BLUE blinks. The device is included in the network when the LED status is OFF and the interview is completed.

Standard exclusion (remove)

Only a controller can remove the device from the network. After activating the exclusion function by the controller, the device can be removed by setting it in **Learn Mode**.

The procedure of exclusion can be activated by **Removing** a node from the Z-Wave™ network and executing 1 or 3 click on the integrated button; as soon as the exclusion initiates, the LED indicator starts a sequence of RED-BLUE blinks. The device is excluded from the network when the LED status indicator is solid RED and the App_status in the interface is OK.

SMARTSTART INCLUSION

Z-Wave™ SmartStart aims to shift the tasks related to inclusion of an end device into a Z-Wave™ network away from the end device itself, and towards the more user-friendly interface of the gateway.

Z-Wave™ SmartStart removes the need for initiating the end device to start inclusion. Inclusion is initiated automatically on power-ON and repeated at dynamic intervals for as long as the device is not included into a Z-Wave™ network. As the new device announces itself on power-ON, the protocol will provide notifications, and the gateway can initiate the inclusion process in the background, without the need for user interaction or any interruption of normal operation. The SmartStart inclusion process only includes authenticated devices.

META Serie 7 devices can be added into a Z-Wave™ network by scanning the Z-Wave™ QR Code present on the product with a controller providing SmartStart inclusion. No further action is required and the SmartStart product will be added automatically within 10 minutes of being switched on in the network vicinity.

The SmartStart QR and the full DSK string code can be found on the back of the device. The PIN is the first group of 5 digits printed underlined. If you plan to use the DSK, it is important that you take a picture of the label and keep it in a safe place.



S2 SECURE INCLUSION

When adding META Serie 7 devices to a Z-Wave™ network with a controller supporting Security 2 Authenticated (S2), the PIN code of the Z-Wave™ Device Specific Key (DSK) is required. The unique DSK code is printed on the product label. The first five digits of the key are highlighted and underlined to help the user identify the PIN code.



SUPPORTED COMMAND CLASSES

Command Class	Version	Non-Secure CC	Secure CC
BASIC	2		X
ZWAVEPLUS_INFO	2	X	
ASSOCIATION	2		X
MULTI_CHANNEL_ASSOCIATION	3		X
ASSOCIATION_GRP_INFO	3		X
TRANSPORT_SERVICE	2	X	
VERSION	3		X
MANUFACTURER_SPECIFIC	2		X
DEVICE_RESET_LOCALLY	1		X
INDICATOR	3		X
POWERLEVEL	1		X
SECURITY_2	1	X	
SUPERVISION	1	X	
FIRMWARE_UPDATE_MD	5		X
APPLICATION_STATUS	1	X	
CONFIGURATION_V4	4		X
SWITCH_BINARY	2		X
CENTRAL_SCENE	3		X

Supporting Command Class Basic

The basic command classes are mapped into the Switch Binary Command Class.

Basic Command received	Commando Mappato (Binary Switch)
Basic Set (0xFF)	Switch Binary Set (0xFF)
Basic Set (0x00)	Switch Binary Set (0x00)
Basic GET	Basic Report 0x00 if the Binary Switch is in OFF state 0x00 Basic Report 0xFF if the Binary Switch is in ON state 0xFF

Supporting Command Class Indicator

The device supports the Command Class Indicator V3 (ID 0x50). When the device receives an indicator set, the led blinks accordingly to the Indicator set received.

The color shown by the indicator will be:

RED: if the device is included without Security

BLUE: if the device is included in S2 Unauthenticated Mode

GREEN: if the device is already included in S2 Authenticated Mode.

DEVICE CONTROL

Meta Dry Contact Switch ZRX can turn ON and OFF the load by using an external switch, or from remote through a controller.

Controlling the device by External Switches

For the operation of the device within the Z-Wave™ network and controlling the loads connected to the device, control actions are performed on the external switches.



The **CONTROL ACTIONS** are **EVENTS** executed on **EXTERNAL SWITCHES** connected to the Line Signal terminal of the device which can be *Clicks, Hold Down and Up*.

Event	Type of switch	Actions on the switch
Click	Momentary switch (button)	Press briefly & Release <i>(when pressed it autonomously returns to the initial position)</i>
	Toggle Switch (bistabile)	Press & Release <i>(a single click means one single flip of the switch)</i>
MultiClick= n click	Momentary switch	Sequence of consecutive n clicks
	Toggle Switch	
Hold Down	Momentary switch	Press longer than click. <i>After a Hold Down always follows an UP event.</i>
Up	Momentary switch	Release. <i>The event applies only if there has been a previous Hold Down event.</i>

Since the device supports Central Scene Notification all the events described in the table will be notified with a Central Scene Notification Report to the Lifeline. The events that trigger a Central Scene Notification Report can be customized with the configuration parameter in the Central Scene Notification Parameter section.

Controlling the device by a Z-Wave™ controller

The device can be controlled by any Z-Wave™ / Z-Wave Plus™ certified controller available in the market.

In the figure below, are represented a couple of examples of control panel interfaces that show how the device will appear once included into the Gateway.

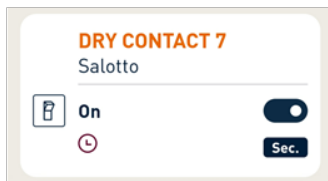
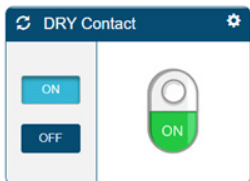

ASSOCIATIONS

Meta Dry Contact Switch ZRX can control other devices like other relays or dimmers. The device supports 5 association groups, each of which supports the association of up to 8 devices (nodes):

Group ID	Group Name	N° max nodes	Description	Command sent
1	Lifeline	8	Lifeline Group. Nodes belonging to this group will receive: notifications about device reset; changes related to the relay status and reports on Indicator and Central Scene Notification.	DEVICE_RESET_LOCALLY_NOTIFICATION SWITCH_BINARY_REPORT CENTRAL_SCENE_NOTIFICATION INDICATOR_REPORT
2	Follow-me	8	The state of the output (ON/OFF) will be propagated to the associated device.	BASIC_SET
3	clicks on button 1 G1	8	The associated device will be controlled based on the click events and output propagation defined by configuration parameters on the Association group management section.	
4	clicks on button 1 G2	8		
5	Dimming Group	8	The devices will be controlled by dimming commands: 1 Click → ON/OFF 2 Click → Max On Level Hold Down → change level in UP/Down direction UP → Stop level Change	SWITCH_MULTILEVEL_SET SWITCH_MULTILEVEL_STOP_LEVEL_CHANGE



INFO: Association ensures direct transfer of control commands between devices and is performed without participation of the main controller.

TIMER MANAGEMENT

A timer can be set when switching On and/or Off. It is also possible to define which event will start the timer. (for example only the change on the output due to double clicks).

RESET TO THE FACTORY SETTINGS

The device can be reset to the original factory with 6 consecutive clicks on the integrated button.

After the reset is completed, the device will reboot and a RED solid led is showed. Please use this procedure only when the network primary controller is missing or otherwise inoperable.



INFO: If the reset is performed while the device is still part of a network, it notifies the other devices that it has been removed (*Device Reset Locally Notification*).

FIRMWARE UPDATE

The system supports over-the-air firmware updates that do not require the device to be removed from its location. The firmware update can be activated from all certified controllers supporting version 2 of the Firmware Update function.



WARNING: The system will be rebooted at the end of the firmware update procedure. It is advisable to carry out the firmware update procedure only when necessary and following careful planning of the intervention.

OFFLINE SETUP MODE

The device has a unique feature that allows to configure some parameters without using any user interface. This feature enables the professional user to setup the main features of the device in the field even if the device is not included in a Z-Wave™ Network. When the device will be included in the network all these configuration parameters will be maintained.

To enter in offline setup mode, operate 2 clicks on the integrated button.

When the device is in Offline setup mode the led becomes solid Blue and the following configurations are permitted:

1 click	Setup input type to toggle switch. Equivalent to set parameter n. 1 to 2.
2 clicks	Activate a switch Off timer of 10 minutes. Equivalent to set parameter n.30 to 15 and parameter n. 31 to 6000.
3 clicks	Activate a switch Off timer of 5 minutes. Equivalent to set parameter n. 30 to 15 and parameter n. 31 to 3000.
After receiving the command the led blinks a number of times equal to the number of clicks recognized.	
6 clicks	Exit from Offline setup mode and return to normal operation.
Hold down for 5 seconds	Reset all configuration parameters to their default value and return to normal operation.

After entering in Offline setup mode, the device returns to normal operation if no action on the switch is detected for more than 20 Seconds.

CONFIGURATIONS

Input Configuration

Parameter Number	Size	Parameter Name	Default Value	Description
1	1	IN_TYPE	1	Define the input type.
Parameters Values			Min: 0	Max: 2
Value	Description			
0	No switch input			
1	Momentary switch (button)			
2	Toggle switch			

Parameter Number	Size	Parameter Name	Default Value	Description
10	1	IN_TOGGLE	15	Define which event on the input 1 toggle output.
Parameters Values			Min: 0	Max: 31
Value	Description			
0	Disabled			
1	1 click			
2	2 clicks			
4	3 clicks			
8	Hold down			
16	Up			

If you support more than 1 event, the value for the configuration parameter is the sum of the event values.

For example:

1 click and 2 clicks -> Parameter value must be $1 + 2 = 3$

1 click and 3 clicks -> Parameter value must be $1 + 4 = 5$

Default Value: 1 click, 2 clicks, 3 clicks, Hold down → 15.

Parameter Number	Size	Parameter Name	Default Value	Description
11	1	IN_ON_EXCLUSION	0	Define which events on the input do not switch-On output.

Parameters Values Min: 0 Max: 31

Value	Description
0	Disable
1	1 click
2	2 clicks
4	3 clicks
8	Hold down
16	Up

If you support more than 1 event, the value for the configuration parameter is the sum of the event values. For example:

1 click and 2 clicks -> Parameter value must be $1 + 2 = 3$

1 click and 3 clicks -> Parameter value must be $1 + 4 = 5$

Default Value: Disable →0

Parameter Number	Size	Parameter Name	Default Value	Description
12	1	IN_OFF_EXCLUSION	0	Define which events on the input do not switch-Off output.

Parameters Values Min: 0 Max: 31

Value	Description
0	Disable
1	1 click
2	2 clicks
4	3 clicks
8	Hold down
16	Up

If you support more than 1 event, the value for the configuration parameter is the sum of the event values. For example:

1 click and 2 clicks -> Parameter value must be $1 + 2 = 3$

1 click and 3 clicks -> Parameter value must be $1 + 4 = 5$

Default Value: Disable →0

Output Configuration:

Parameter Number	Size	Parameter Name	Default Value	Description
21	1	OUT_TYPE	0	Define the output type.
Parameters Values			Min: 0	Max: 1
Value	Description			
0	Direct load or normally Open relay			
1	Normally Closed relay			

Parameter Number	Size	Parameter Name	Default Value	Description
23	1	STARTUP_OUT	2	Define the output level on startup (status of the device following a restart)
Parameters Values			Min: 0	Max: 3
Value	Description			
0	OFF			
1	ON			
2	Previous status			
3	Equal to input (ON if input close, OFF if input open)			

Timer management

It allows you to activate an ON and OFF timer independently. To activate the timers you need to:

- 1) Define which event will start the timer (Parameter 30)
- 2) To set the Off timer define the time with parameter 31
- 3) To set the On timer define the time with parameter 32.

Parameter Number	Size	Parameter Name	Default Value	Description
30	1	TIMER_SETUP	0	Define which trigger events activate the timers when output status has changed.
Parameters Values			Min: 0	Max: 127
Value	Description			
0	Disabled			
1	1 click			
2	2 clicks			
4	3 clicks			
8	Hold down			
16	Up			
32	Network (status change trigger by gateway or other devices in the Z-Wave™ network).			
64	System (based on the startup status, or other timer event).			
If more than 1 event are supported, the value for the configuration parameter is the sum of the event values. For example: 1 click and 2 clicks -> Parameter value must be $1 + 2 = 3$ Default value: Disabled →0				

Parameter Number	Size	Parameter Name	Default Value	Description
31	4	OFF_TIMEOUT	0	Time in tenth of seconds after which the output will be switched Off.
Parameters Values			Min: 0	Max: 360000
Value	Description			
0-360000	Specific time expressed in tenth of seconds for Status change.			

Parameter Number	Size	Parameter Name	Default Value	Description
32	4	ON_TIMEOUT	0	Time in tenth of seconds after which the output will be switched On.
Parameters Values			Min: 0	Max: 360000
Value	Description			
0-360000	Specific time expressed in tenth of seconds for Status change.			

Association group management

This section defines the configuration parameters associated respectively with the control groups G1, G2, and dimming.

Parameter Number	Size	Parameter Name	Default Value	Description
40	1	G1_SETUP	1	Define which events on the input control G1 association group.
Parameters Values			Min: 0	Max: 31
Value	Description			
0	No control			
1	1 click			
2	2 clicks			
4	3 clicks			
8	Hold down			
16	Up			
<p>If you support more than 1 event, the value for the configuration parameter is the sum of the event values. For example: 1 click and 2 clicks -> Parameter value must be $1 + 2 = 3$ 1 click and 3 clicks -> Parameter value must be $1 + 4 = 5$ Default value: 1 click → 1</p>				

Parameter Number	Size	Parameter Name	Default Value	Description
41	1	G2_SETUP	2	Define which events on the input control G2 association group.
Parameters Values			Min: 0	Max: 31
Value	Description			
0	No control			
1	1 click			
2	2 clicks			
4	3 clicks			
8	Hold down			
16	Up			
<p>If you support more than 1 event, the value for the configuration parameter is the sum of the event values. For example:</p> <p>1 click and 2 clicks -> Parameter value must be $1 + 2 = 3$</p> <p>1 click and 3 clicks -> Parameter value must be $1 + 4 = 5$</p> <p>Default value: 2 clicks →2</p>				

Parameter Number	Size	Parameter Name	Default Value	Description
44	1	G1_ASS_VALUE	101	Define which events on the input control G2 association group.
Parameters Values			Min: 0	Max: 102
Value	Description			
0	OFF			
1-99	Specific diming value			
100	ON			
101	Propagate (<i>output 1 status to the associated device</i>)			
102	Toggle remote (<i>change status ON/OFF of associated devices</i>)			

Parameter Number	Size	Parameter Name	Default Value	Description
45	1	G2_ASS_VALUE	101	The value used to control G2 association group.
Parameters Values			Min: 0	Max: 102
Value	Description			
0	OFF			
1-99	Specific diming value			
100	ON			
101	Propagate (<i>output 1 status to the associated device</i>)			
102	Toggle remote (<i>change status ON/OFF of associated devices</i>)			

Parameter Number	Size	Parameter Name	Default Value	Description
50	4	DIMMING_TIME	5	Fade On/Off time in second used to control device in dimming group.
Parameters Values			Min: 0	Max: 3600
Value	Description			
0-3600	Specific time expressed in seconds.			

Parameter Number	Size	Parameter Name	Default Value	Description
51	1	MIN_DIM_LEVEL	1	Define the minimum dimming level to control the device in a dimming group.
Parameters Values			Min: 1	Max: 99
Value	Description			
1-99	Specify the minimum dimming value (not null)			

Central Scene management

Parameter Number	Size	Parameter Name	Default Value	Description
60	1	SCENE_SETUP	31	Define which event on the input trigger a central scene notification.
Parameters Values			Min: 0	Max: 31
Value	Description			
0	None			
1	1 click			
2	2 clicks			
4	3 clicks			
8	Hold down			
16	Up			
<p>If more than 1 event are supported, the value for the configuration parameter is the sum of the event values. For example: 1 click and 2 clicks -> Parameter value must be $1 + 2 = 3$ 1 click and 3 clicks -> Parameter value must be $1 + 4 = 5$ Default value: all event →31</p>				



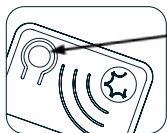

ASSOCIATION OF A CHERUBINI REMOTE CONTROL SKIPPER - POP OR GIRO SERIES

LEGEND OF THE SYMBOLS:

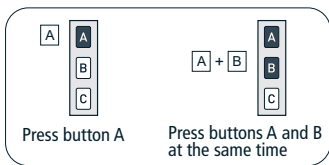

Integrated
Button with
LED indicator



 Single BLUE Blink	Confirmation of sequence start recognition.
 Sequence of GREEN - BLUE	Confirmation of recognition of the Operation required. Duration of about 4 seconds, time within which the command confirmation must take place.
 4 GREEN blinks	Confirmation that the requested operation was completed successfully.
 4 RED blinks	The requested operation has not been carried out.
 4 BLUE blinks	Confirmation that all remotes have been deleted.

Setting the first remote control

This operation can only be performed when the product is new, or after a total delete of the memory. Every time you connect the device to the power supply, you have 3 hours to store the first remote control. After this time, the ability to store the remote control is disabled. To reset the timer of the function you have to disconnect and reconnect the power supply to the device, or to activate the procedure of deleting all the remote controls as described below.

The operation can be performed in two ways:

T1: First remote control to be set

1) Setting through operations with the remote control

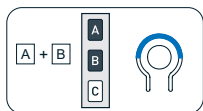

T1

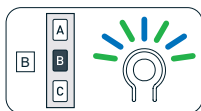

T1

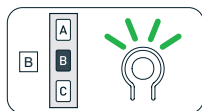

T1 (2 sec)

2) Setting through operations with both remote control and device.

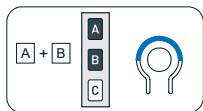

T1

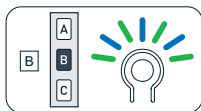

T1



2 sec

Setting additional remote controls

It is possible to set up to 15 remote controls.

Tn: Already programmed remote control

Tx: Additional remote control

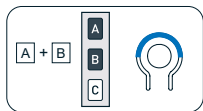

Tn

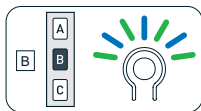

Tn

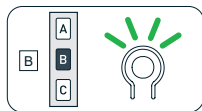

Tx (2 sec)

Remote control memory clearing

It is possible to delete singly all the memorized remote controls. When the last one is deleted the motor initial condition is restored. The same applies to single channels of a multichannel remote control: just select the channel before performing the sequence.

Tn: Remote control to be cleared

This sequence deletes the remote control from all associated receivers.

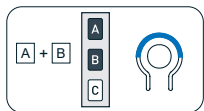

Tn

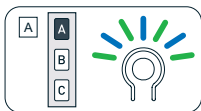

Tn

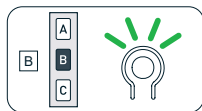

Tn (2 sec)

This sequence deletes the remote control from only one receiver.

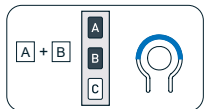

Tn

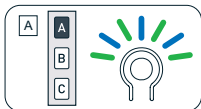

Tn



2 sec

Clearing all remote controls



Total clearing from the memory is carried out by holding down the button integrated in the device for 5 seconds as indicated below



5 sec

Controlling the device from a Cherubini Remote Control

The events on the buttons of the remote control allow the controlling of the load as indicated in the following table.

Button	Event	Result
	Click	Switching on the load ON.
	Hold Down	
	Click	Changing the load status (from ON to OFF and vice versa).
	Hold Down	
	Click	Switching on the load OFF.
	Hold Down	

CHERUBINI S.p.A.

Via Adige 55
25081 Bedizzole (BS) - Italy
Tel. +39 030 6872.039 | Fax +39 030 6872.040
info@cherubini.it | www.cherubini.it

CHERUBINI Iberia S.L.

Avda. Unión Europea 11-H
Apdo. 283 - P. I. El Castillo
03630 Sax Alicante - Spain
Tel. +34 (0) 966 967 504 | Fax +34 (0) 966 967 505
info@cherubini.es | www.cherubini.es

CHERUBINI France S.a.r.l.

ZI Du Mas Barbet
165 Impasse Ampère
30600 Vauvert - France
Tél. +33 (0) 466 77 88 58 | Fax +33 (0) 466 77 92 32
info@cherubini.fr | www.cherubini.fr

CHERUBINI Deutschland GmbH

Siemensstrasse, 40 - 53121 Bonn - Deutschland
Tel. +49 (0) 228 962 976 34 / 35 | Fax +49 (0) 228 962 976 36
info@cherubini-group.de | www.cherubini-group.de

