

CHERUBINI

tocco italiano dal 1947

PLUG & PLAY PLUS

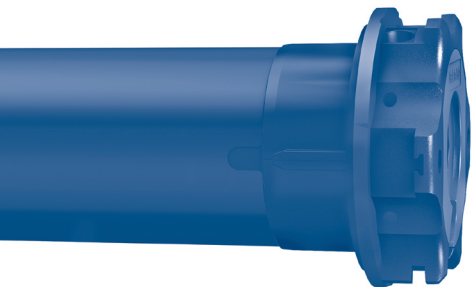

TUBULAR MOTOR WITH AUTOMATIC OR MANUAL
ADJUSTMENT OF THE ELECTRONIC LIMIT SWITCH

EN

TÜP MOTORU İLE OTOMATİK YADA
MANUEL ELEKTRONİK LİMİTLİ AYARI

TR



INSTRUCTIONS - KILAVUZLAR

Table of contents:

Electrical connections	p. 4
Electrical connections Plug & Play Plus - Wave Wire	p. 5
Electrical connections Plug & Play Short	p. 5
How to prepare the motor	p. 6
Restoring the original configuration	p. 7
Plug & Play Short - Plug & Play Plus	
Instruction for use in automatic mode	p. 7
Plug & Play Plus - Wave Wire	
Instruction for use in manual mode	p. 8
Instruction for use in mixed mode.....	p. 8
Key to symbols	p. 8
Command sequences example	p. 8
Adjustment of the limit switches with Plug & Play Plus	p. 9
Adjustment of the limit switches with Wave Wire	p. 9
Deletion of individual limit switch positions	p. 10
Deleting the opening and closing limit switch	p. 10
Motor actions at limit switch stops and obstacles	p. 11
EU declaration of conformity	p. 11

ELECTRICAL CONNECTIONS

- To prevent any danger or malfunction, the size of electrical control components connected to the motor must be compatible with the electrical features of the motor.
- Means for disconnection must be incorporated in the fixed wiring in accordance with the national installation standards.
- The selectors inverting the direction of rotation of the motor must be provided with mechanical interlocking.
- Invert the brown and the black conductor to change the direction of rotation.
- **NEVER** connect two or more selectors to the same motor.
- For outdoor use, provide the appliance with a supply cord with designation H05RN-F containing at least 2% of carbon.
- Cable length between motor and control-switch maximal 50 m.
In case of cable length more than 50 m an interface-relay have to be used.

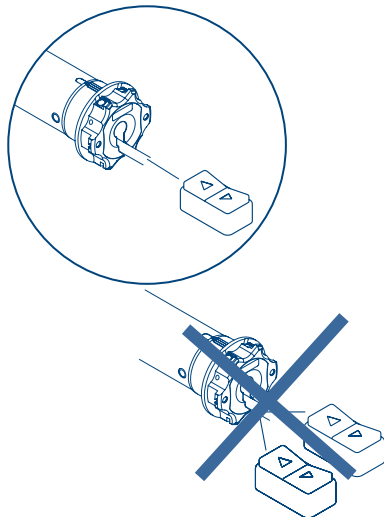
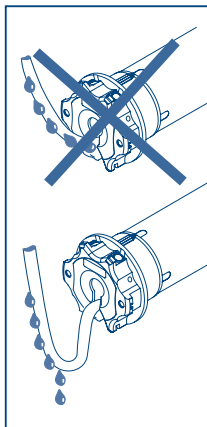

ELECTRICAL CONNECTIONS PLUG & PLAY PLUS - WAVE WIRE



- 1- brown
- 2- black
- 3- blue
- 4- yellow-green

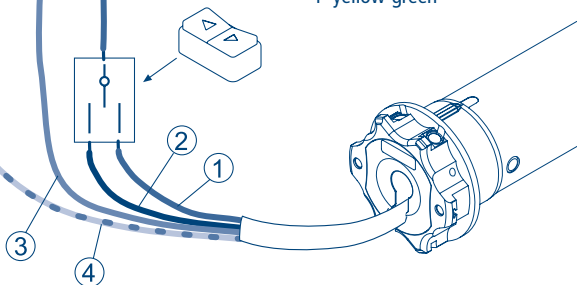

ENGLISH

ELECTRICAL CONNECTIONS PLUG & PLAY SHORT



- 1- brown
- 2- black
- 3- blue
- 4- yellow-green

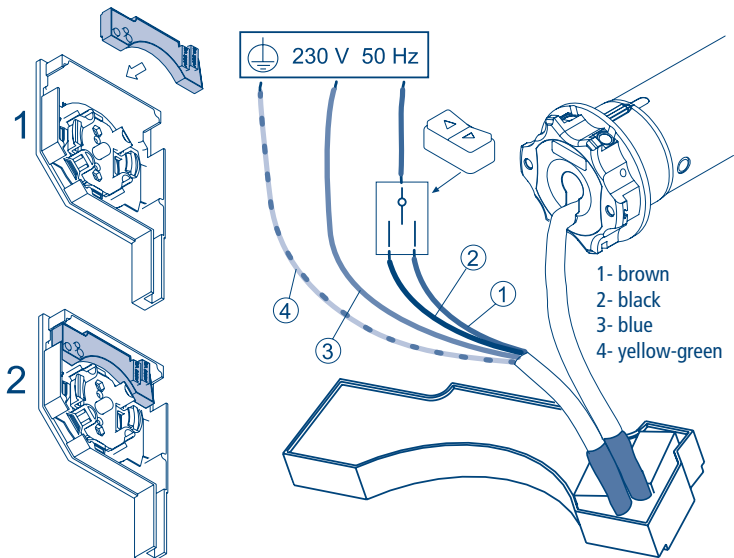

HOW TO PREPARE THE MOTOR

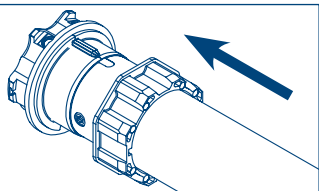
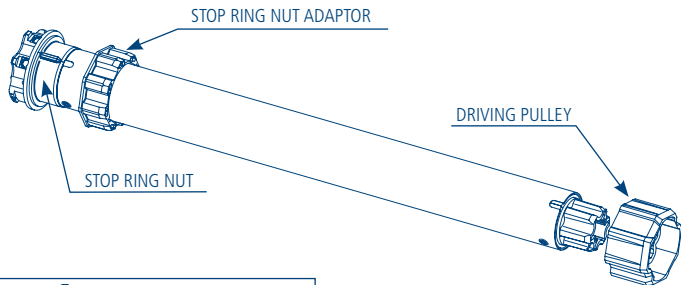

1. Insert the adaptor in the stop ring nut mating the groove with the reference notch and push till they touch.

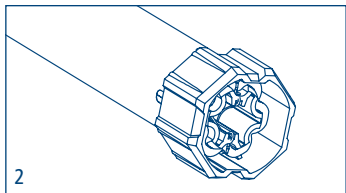

2. Fix the driving pulley on the motor pin until the stop pin clicks.

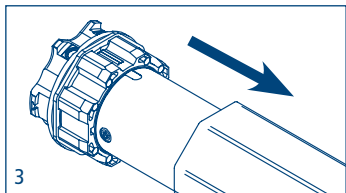

3. Insert the motor fully in the rolling tube.

NB: If you use tubes with a round form, the driving pulley must be fixed to the tube, and the installation is to be paid by the person who installs the system. For other tube sections the fitting is optional, but strongly recommended.

RESTORING THE ORIGINAL CONFIGURATION

To restore the original motor configuration perform the procedure as described below:

- Connect both the brown and black motor wires under the same switch, e.g. UP.
- Press the UP button for at least 2 seconds.
- Disconnect and then restore the original control switch electrical connections (see page 14).

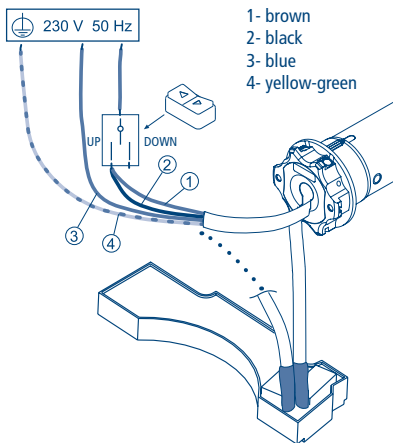

PLUG & PLAY Short - PLUG & PLAY Plus

INSTRUCTION FOR USE IN AUTOMATIC MODE

The tubular motor is very simple to be used and installed, it does not need any regulation as it automatically detects the position of limit switch.

The rolling shutter must be equipped with:

- a) security locks or stiff fixing springs,
- b) fixed or removable stoppers for end slats.

It is very important to check the sturdiness of the rolling shutter.

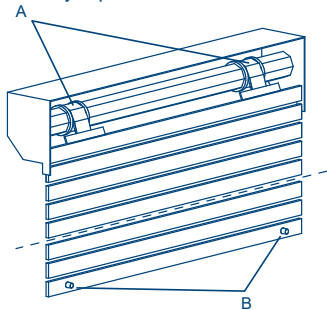

PLEASE NOTE: Until both limit switch positions have been memorized:

- **PLUG & PLAY Plus** at start up the motor makes an initial brief movement with a 0.5 second delay and then it moves with a 0.5 second delay.

PLUG & PLAY Plus - WAVE WIRE

INSTRUCTION FOR USE IN MANUAL MODE

PLUG & PLAY Plus	WAVE WIRE
In this mode the following devices are optional: a) security locks or stiff fixing springs, b) fixed or removable stoppers for end slats.	The motor Wave Wire is specific for use with cassette awning: the upper limit switch (closing position) can be set automatically. For other types of awnings it's possible to set both limit switches manually.

INSTRUCTION FOR USE IN MIXED MODE

It is always possible to memorize limit switches of the rolling shutter/awning in mixed mode, for example:

- Opening limit switch: automatic with mechanical blocks.
- Closing limit switch: manual with sequence on the button panel.

KEY TO SYMBOLS



Press the
UP-button



Press the
DOWN-button

UP ↑
DOWN ↓

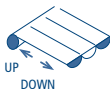

Press the buttons quickly according to the sequence indicated.

PLEASE NOTE: Until both limit switch positions have been memorized:

- **PLUG & PLAY Plus** at start up the motor makes an initial brief movement with a 0.5 second delay and then it moves with a 0.5 second delay.
- **Wave Wire** at start up the motor moves with a 0.5 second delay.

COMAND SEQUENCES EXAMPLE

Most of the command sequences have three or six distinct steps.

The buttons must be pressed for less than 0.5 seconds as shown in the sequence, without taking more than 1 second between one step and the next. If more than 1 second is taken, the command is not accepted and the sequence must be repeated.

Command sequence example:

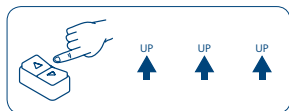

Attention! If the sequence requires a repetition of the same commands (Up+Up/ Down+Down), an interposition of the Stop position could be necessary depending on the type of switch in use.

ADJUSTMENT OF THE LIMIT SWITCHES WITH PLUG & PLAY Plus

SETTING THE UPPER LIMIT SWITCH POSITION

If the rolling shutter is completely open, you have firstly to drive it down by around 20 cm.

Bring the rolling shutter to the opening position using the UP button. Follow the command sequence given in order to save the opening position (UP-UP-UP).

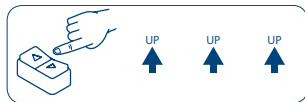
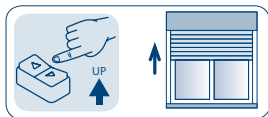

SETTING THE LOWER LIMIT SWITCH POSITION

Bring the rolling shutter to the closing position using the DOWN button. Follow the command sequence given in order to save the closing position (DOWN-DOWN-DOWN).

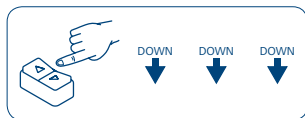
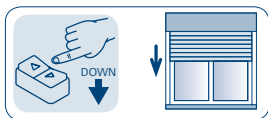

ADJUSTMENT OF THE LIMIT SWITCHES WITH WAVE WIRE

SETTING THE UPPER LIMIT SWITCH POSITION

If the awning is completely closed, you have firstly to drive it down by around 20 cm.

Bring the awning to the closing position using the UP button. Follow the command sequence given in order to save the closing position (UP-UP-UP).

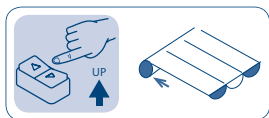

SETTING THE LOWER LIMIT SWITCH POSITION

Bring the awning to the opening position using the DOWN button. Follow the command sequence given in order to save the opening position (DOWN-DOWN-DOWN).

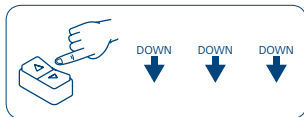
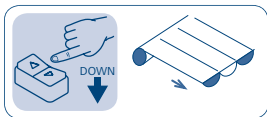

DELETION OF INDIVIDUAL LIMIT SWITCH POSITIONS

Deletion of the UPPER limit switch

Bring the rolling shutter/awning to the upper limit switch and proceed as follows:

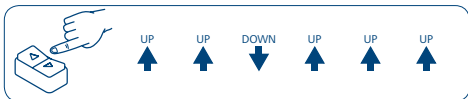

Deletion of the LOWER limit switch

Bring the rolling shutter/awning to the lower limit switch and proceed as follows:

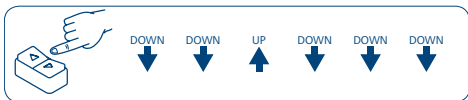

DELETING THE OPENING AND CLOSING LIMIT SWITCH

Deletion of the limit switches from the UPPER limit switch position

Bring the rolling shutter/awning to the upper limit switch and proceed as follows:

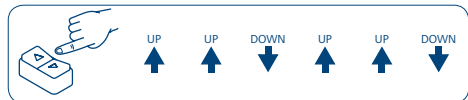

Deletion of the limit switches from the LOWER limit switch position

Bring the rolling shutter/awning to the lower limit switch and proceed as follows:

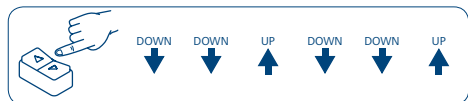

After deletion of one or both limit switches the motor has a 0.5 seconds run delay until both limit switch positions have been memorised again either in automatic or manual mode.

MOTOR ACTIONS AT LIMIT SWITCH STOPS AND OBSTACLES

	LIMIT SWITCH STOPS (blinds with stoppers and/or stiff fixing springs, or cassette awnings).	OBSTACLE DETECTION WHEN ASCENDING AND DESCENDING (only when descending for blinds with stiff fixing springs).
P&P Plus Ø 35 P&P Plus Ø 35 V43	It always goes to the stop and reverses direction to release tension.	P&P Plus Ø 35 it stops and reverses direction for 1/3 of the travel. P&P Plus Ø 35 V43 it stops and does not reverse direction.
Wave Wire P&P Short (Until 12/2017)	It always goes to the stop and DOES NOT reverse direction to release tension.	It stops and does not reverse direction.
P&P Short (Starting from 01/2018)	It always goes to the stop and reverses direction to release tension.	It stops and reverses direction to release tension.

ENGLISH

After the limit switches have been set, the motors act differently when they reach the mechanical stop or if there is an obstacle.

EU DECLARATION OF CONFORMITY



CHERUBINI S.p.A. declares that the product is in conformity with the relevant Union harmonisation legislation:

Directive 2014/35/EU

Directive 2014/30/EU

Directive 2011/65/EU

The full text of the EU declaration of conformity is available upon request at the following website: www.cherubini.it.

Liste:

Elektrik bağlantıları	s. 13
Plug & Play Plus - Wave Wire elektrik bağlantıları	s. 14
Plug & Play Short elektrik bağlantıları	s. 14
Motorun hazırlanması	s. 15
Orijinal konfigürasyonu geri yükle	s. 16
Plug & Play Short - Plug & Play Plus	
kullanma kılavuzunun otomatik şekli	s. 16
Plug & Play Plus - Wave Wire	
Kullanma kılavuzunun manuel şekli	s. 17
Kullanma kılavuzunun her iki şekli	s. 17
Sembollerin açıklaması	s. 17
Komut dizilerinin açıklaması	s. 17
Plug & Play Plus ile limitli hafızaya alma	s. 18
Wave Wire ile limitli hafızaya alma	s. 18
Tek limitli pozisyonlarının silinmesi	s. 19
Limitli pozisyonlarının tümünün silinmesi	s. 19
Vuruşta limitli ve engel üzerinde motor bağlantıları	s. 20
Uygunluk beyanı	s. 20

ELEKTRİK BAĞLANTILARI

- Tehlikeli durumlardan ve arızalardan kaçınmak için, motora bağlı elektriksel kontrol elemanları, motorun elektriksel özelliklerine göre boyutlandırılmalıdır.
- Bağlantı kesme cihazları, ulusal kurulum kurallarına uygun olarak tedarik ağında sağlanmalıdır.
- Motorun dönüş yönünü tersine çevirmek için motorlar mekanik bir kilitle donatılmalıdır.
- Dönüş yönünü değiştirmek için kahverengi ve siyah tellerin yerlerini değiştirin.
- Aynı motora iki veya daha fazla selektör bağlamayın.
- Dış mekanda kullanım durumunda, H05RN-F karbon içeriği min % 2
- Selektör ile motor arasında 50 metreden uzun bağlantı kabloları kullanmayın. Motorun bu mesafenin ötesinde kontrol edilmesi gerekiyorsa, bir izolasyon rölesini yerleştirin.

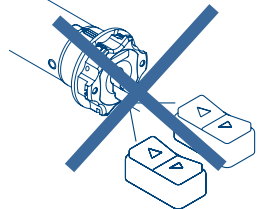
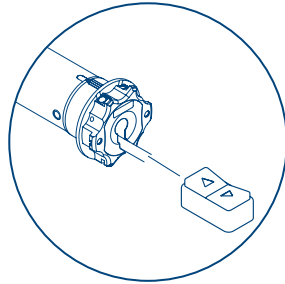
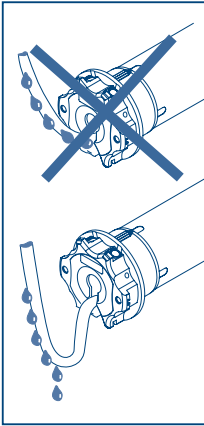

PLUG & PLAY PLUS - WAVE WIRE ELEKTRİK BAĞLANTILARI

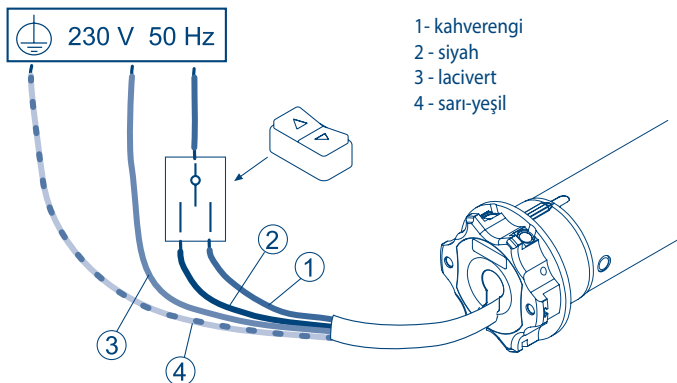

PLUG & PLAY SHORT ELEKTRİK BAĞLANTILARI

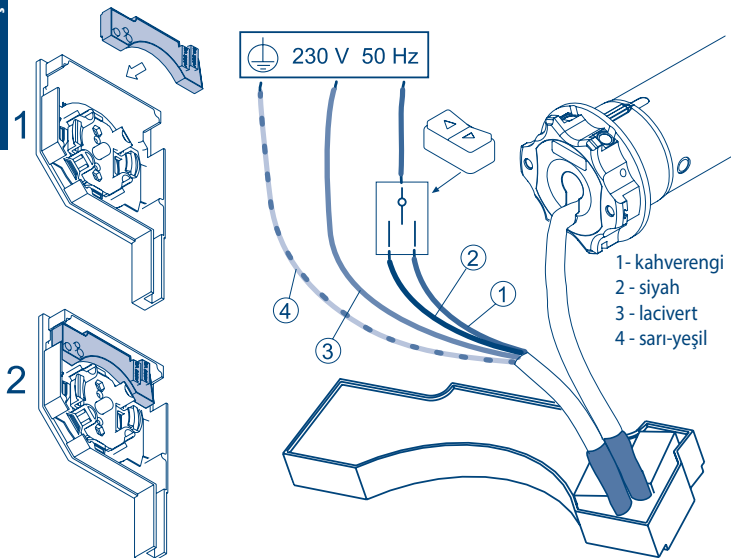

MOTORUN HAZIRLANMASI

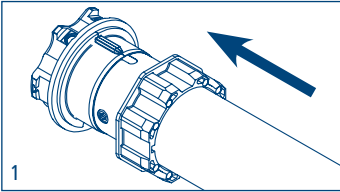
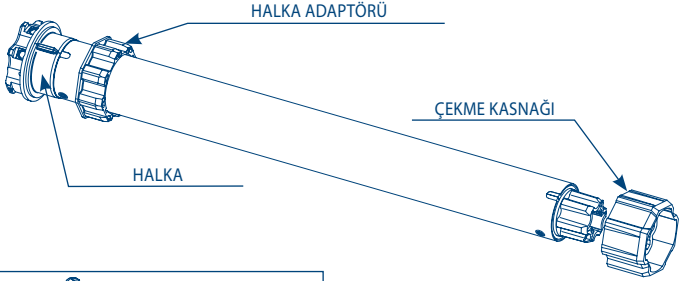

1. Adaptörü halka somununa takın, oluğu referans çentiği ile eşleştirin ve sonuna kadar itin.

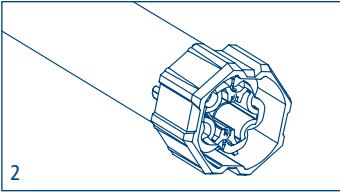

2. Çekme kasnağını, kilit yayı tıklayana kadar motor pimine takın.

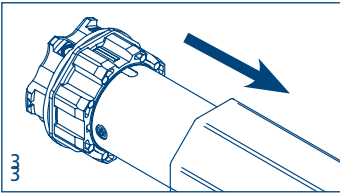

3. Motoru sarım borusuna tamamen yerleştirin.

Not: Yuvarlak profilli borular, çekme kasnağı boruya sabitlenmelidir, bu işlem montajcının sorumluluğundadır. Diğer boru profilleri için montaj kesinlikle önerilse de isteğe bağlıdır.

ORJİNAL KONFÜGÜRASYONU GERİ YÜKLE

Motorun orijinal konfüğürasyonunu geri yüklemek için, aşağıdaki prosedürü izleyin:

- Kahverengi ve Siyah motor kablolarını aynı düğmenin altına bağlayın, örnek. YUKARDA;
- YUKARI düğmesine en az 2 saniye boyunca basın;
- Kontrol düğmelerinin elektrik bağlantısını kesin ve geri takın (bkz. sayfa 5).

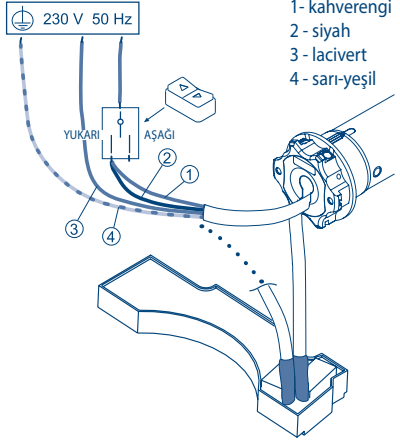

- 1 - kahverengi
- 2 - siyah
- 3 - lacivert
- 4 - sarı-yeşil

PLUG & PLAY Short - PLUG & PLAY Plus

KULLANMA KILAVUZLARIN OTOMATİK ŞEKLİ

Motorun kurulumu ve kullanımı basittir, limitli otomatik olarak algıladığından herhangi bir ayarlamaya ihtiyaç duymaz.

Panjur aşağıdakilerle donatılmış olmalıdır:

- A - Sert veya yaylı emniyet askı aparatı,
- B - Sabit veya kızaklarda hareketli emniyet tapaları.

Daima panjurların sağlamlığını kontrol edin.

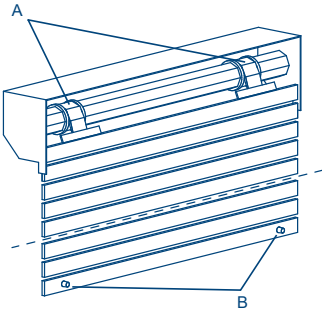

NOT: Limitli her iki konumu da hafızaya alınmadığı sürece:

- **PLUG & PLAY Plus**, motor çalışmasıyla 0,5 saniyelik gecikme ile kısa bir ilk hareketi yapar ve daha sonra 0,5 saniye gecikme ile hareket eder.

PLUG & PLAY Plus - WAVE WIRE

KULLANMA KILAVUZLARIN MANUEL ŞEKLİ

PLUG & PLAY Plus	WAVE WIRE
Bu modda, isteğe bağlı olarak aşağıdaki cihazların mevcuttur: A - Sert veya yaylı emniyet askı aparatı, B- Sabit veya kızaklarda hareketli emniyet tapaları.	Wave Wire motoru, bir kutu ile perdelerde kullanıma özeldir: limitli kapanırken (kaldırmada) otomatik olarak programlanabilir. Diğer panjur tipleri için her iki limitli manuel olarak programlanabilir.

KULLANMA KILAVUZLARIN HER İKİ ŞEKLİ

Panjurların / perdelerin son konumlarının karışık hafızaya almak mümkündür, örneğin:

- Limitli açma: otomatik vuruş;
- Limitli Kapama: düğme dizisi ile manuel.

SEMBOLERİN AÇIKLANMASI



kaldırma
düğmesine
basın



indirme
düğmesine
basın

KALDIRMA
(UP) ↑
İNDİRME
(DOWN) ↓

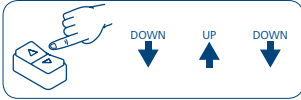
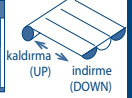

Hızlı olarak sıralamada gösterilen tuşlara basın

NOT: Limitli her iki konumu da hafızaya alınmadığı sürece:

- **PLUG & PLAY Plus**, motor çalışmasıyla 0,5 saniyelik gecikme ile kısa bir ilk hareketi yapar ve daha sonra 0,5 saniye gecikme ile hareket eder.
- Başlangıçta **Wave Wire**, motor 0,5 saniyelik bir gecikme ile hareket eder.

KOMUT DİZİLERİNİN AÇIKLANMASI

Çoğu komut dizisi üç veya altı ayrı adımdan oluşur. Düğmeler, bir adım ile diğeri arasında 1 saniyeden fazla geçmeden, sırayla belirtildiği gibi 0,5 saniyeden daha az bir süreyle basılmalıdır. 1 saniyeden fazla geçerse, komut kabul edilmez ve sıra tekrarlanmalıdır.

3 adımda bir komut dizisi örneği:

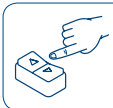

UP
↑

UP
↑

UP
↑

Uyarı! Sıra, aynı komutların tekrarlanmasını öngörüyorsa (Yukarı + Yukarı / Aşağı + Aşağı), düğme paneli tipi bunu öngörüyorsa Durdurma konumunu aralamak gerekir.

PLUG & PLAY Plus İLE LİMİTLİ HAFIZAYA ALMA

ÜST LİMİTLİ POZİSYONU HAFIZAYA ALMA

Panjur tamamen sarılmışsa, önce yaklaşık 20 cm indirilmelidir.

Düğme panelin kaldırma düğmeleriyle, panjurlar istenen açılış konumuna getirin. Açık pozisyonu hafızaya almak için, belirtilen komut dizisini (UP-UP-UP) yürütün.

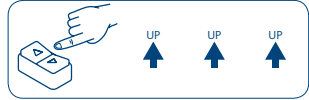
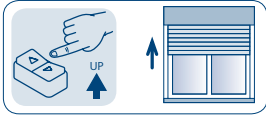

ALT LİMİTLİ POZİSYONU HAFIZAYA ALMA

Panelin indirme düğmesiyle, panjurlar istenen kapatma konumuna getirin. Kapama pozisyonunu hafızaya almak için, belirtilen komut dizisini (DOWN-DOWN-DOWN) yürütün.

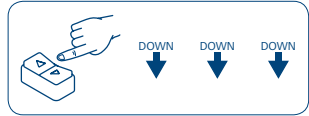
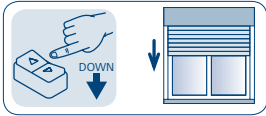

WAVE WIRE İLE LİMİTLİ HAFIZAYA ALMA

ÜST LİMİTLİ POZİSYONU HAFIZAYA ALMA

Tente tamamen sarılmışsa, önce yaklaşık 20 cm indirmeniz gerekir.

Düğme panelin kaldırma düğmeleri ile, tenteleri istenilen kapanma konumuna getirin. Kapalı pozisyonu hafızaya almak için, belirtilen komut dizisini (UP-UP-UP) yürütün.

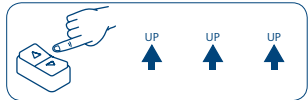
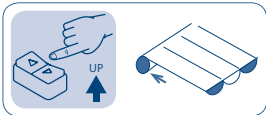

ALT LİMİTLİ POZİSYONU HAFIZAYA ALMA

Düğme panelini indirme düğmesini kullanarak tenteleri istenen açık konuma getirin. Açılış konumunu hafızaya almak için, belirtilen komut dizisini yürütün (DOWN-DOWN-DOWN).

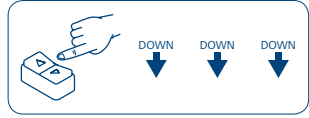
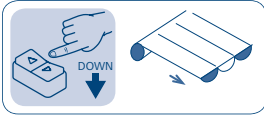

TEK LİMİTLİ POZİSYONLARININ SİLİNMESİ

ÜST limitli silme

Panjur / tente üst uç konumuna getirin ve belirtilen sıralamayı uygulayın:

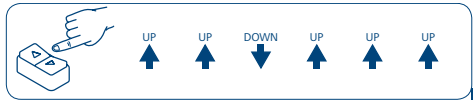

ALT limitli silme

Panjur / tente alt uç konumuna getirin ve belirtilen sıralamayı uygulayın:



LİMİTLİ POZİSYONLARININ TÜMÜNÜN SİLİNMESİ

ÜST limitli pozisyonundan limitli silinmesi,

Panjur / tente üst uç konumuna getirin ve belirtilen sıralamayı uygulayın:



ALT limitli pozisyonundan limitli silinmesi,

Panjur / tente alt uç konumuna getirin ve belirtilen sıralamayı uygulayın:

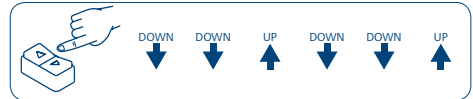

Her iki pozisyon da otomatik veya manuel modda tekrar hafızaya alınana kadar, bir veya iki limitli iptal ettikten sonra motor 0,5 saniyelik bir gecikme ile hareket eder.

VURUŞTA LİMİTLİ VE ENGEL ÜZERİNDE MOTOR BAĞLANTILARI

	VURUŞTA LİMİTLİ (tapalar ve / veya sert askı aparatı ile panjur veya kutu tente).	KALDIRMA VE İNDİRMEDE ENGELLERİ ALGILAMA (sadece sert askı aparatına sahip panjurlar için inirmede).
P&P Plus Ø 35 P&P Plus Ø 35 V43	Her zaman çalışır ve gevşemenin karşıt hareketini gerçekleştirir.	P&P Plus Ø 35 , turun 1 / 3'ü için hareketi durdurur ve tersine çevirir. P&P Plus Ø 35 V43 durur ve hareketi ters çevirmez.
WAVE WIRE P&P Short (12/2017'ye kadar)	Her zaman devam eder ve gevşemenin zıt hareketini gerçekleştiremez.	Durur ve hareketi tersine çevirmez.
P&P Short (01/2018'den itibaren)	Her zaman çalışır ve gevşemenin karşıt hareketini gerçekleştirir.	Gevşemenin zıt hareketini durdurur ve sürdürür.

TÜRKÇE

Limitli tanındıktan sonra, motorlar mekanik durma noktasına ulaşırken veya engellerin varlığında farklı davranırlar.

UYGUNLUK BEYANI



Cherubini S.p.A. motorların yönetmeliklere uygun olduğunu beyan eder:

2014/35/AB Yönetmeliği

2014/30/AB Yönetmeliği

2011/65/AB Yönetmeliği

AB uygunluk beyanının tam metni, talep üzerine www.cherubini.it adresinde mevcuttur.

CHERUBINI S.p.A.

Via Adige 55
25081 Bedizzole (BS) - Italy
Tel. +39 030 6872.039 | Fax +39 030 6872.040
info@cherubini.it | www.cherubini.it

CHERUBINI Iberia S.L.

Avda. Unión Europea 11-H
Apdo. 283 - P. I. El Castillo
03630 Sax Alicante - Spain
Tel. +34 (0) 966 967 504 | Fax +34 (0) 966 967 505
info@cherubini.es | www.cherubini.es

CHERUBINI France S.a.r.l.

ZI Du Mas Barbet
165 Impasse Ampère
30600 Vauvert - France
Tél. +33 (0) 466 77 88 58 | Fax +33 (0) 466 77 92 32
info@cherubini.fr | www.cherubini.fr

CHERUBINI Deutschland GmbH

Siemensstrasse, 40 - 53121 Bonn - Deutschland
Tel. +49 (0) 228 962 976 34 / 35 | Fax +49 (0) 228 962 976 36
info@cherubini-group.de | www.cherubini-group.de

Cherubini Türkiye

Ritim Istanbul - D-100 Güney Yanyolu
Cevizli Mahallesi, Zuhul Caddesi
34846 Maltepe - Istanbul
Tel/Fax +90 (0) 216 515 6287
info@cherubini.com.tr | www.cherubini.com.tr

